

SAMSUNG

MICROWAVE OVEN

Owner's Instructions

M1817N

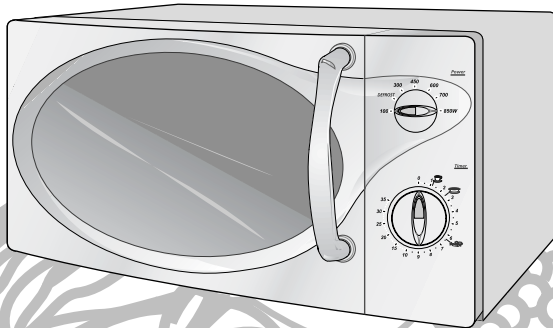

| | |
|--|---|
| Oven | 2 |
| Accessories | 2 |
| Control Panel..... | 2 |
| Using this Instruction Booklet..... | 3 |
| Safety Precautions | 3 |
| Installing Your Microwave oven | 4 |
| What to Do if You are in Doubt or Have a Problem | 5 |
| Cooking / Reheating..... | 5 |
| Power Levels..... | 5 |
| Stopping the Cooking..... | 6 |
| Adjusting the Cooking Time | 6 |
| Manual Defrosting of Food..... | 6 |
| Using the Instant Reheat Feature | 6 |
| Instant Reheat Settings..... | 6 |
| Cookware Guide | 7 |
| Cleaning Your Microwave Oven | 8 |
| Technical Specifications..... | 8 |

Oven

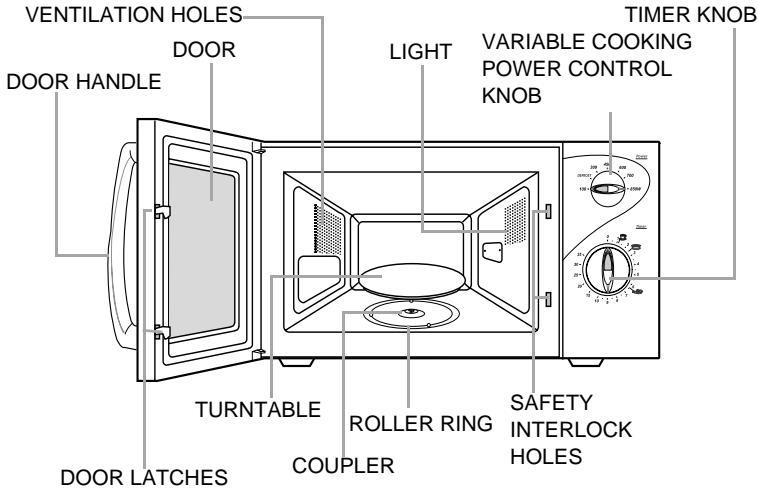

Accessories

Depending on the model that you have purchased, you are supplied with several accessories that can be used in a variety of ways.

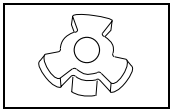

1. **Coupler**, already placed over the motor shaft in the base of the oven.
Purpose: The coupler rotates the turntable.

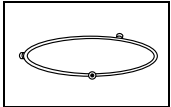

2. **Roller ring**, to be placed in the centre of the oven.
Purpose: The roller ring supports the turntable.

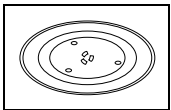

3. **Turntable**, to be placed on the roller ring with the centre fitting to the coupler.
Purpose: The turntable serves as the main cooking surface; it can be easily removed for cleaning.



DO NOT operate the microwave oven without the roller ring and turntable.

Control Panel

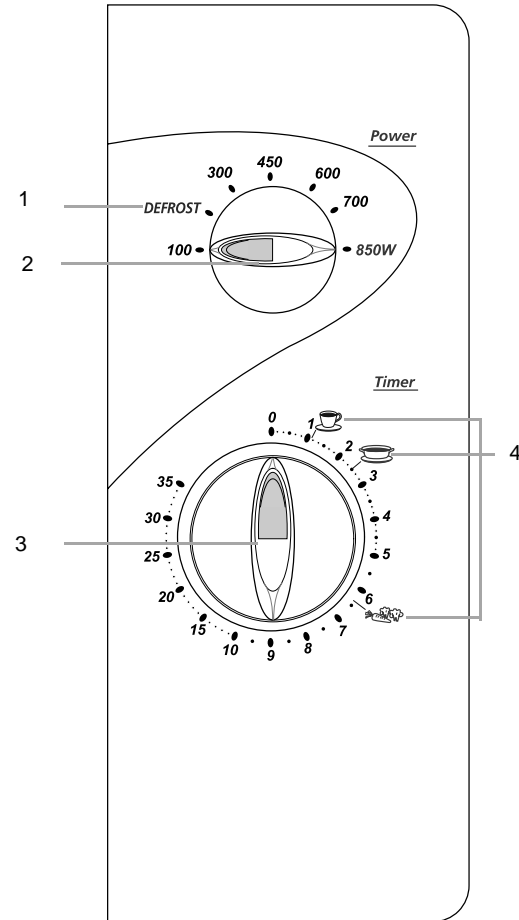

1. MANUAL DEFROST
2. VARIABLE COOKING POWER CONTROL KNOB
3. TIMER KNOB
4. INSTANT REHEAT

Using this Instruction Booklet

You have just purchased a SAMSUNG microwave oven. Your Owner's Instructions contain much valuable information on cooking with your microwave oven:

- Safety precautions
- Suitable accessories and cookware
- Useful cooking tips

At the front of the booklet you will find illustrations of the oven, and more importantly the control panel, so that you can find the buttons more easily.

The step-by-step procedures use three different symbols.



Importante



Nota



Turn

PRECAUTIONS TO AVOID POSSIBLE EXPOSURE TO EXCESSIVE MICROWAVE ENERGY

Failure to observe the following safety precautions may result in harmful exposure to microwave energy.

- Under no circumstances should any attempt be made to operate the oven with the door open or to tamper with the safety interlocks (door latches) or to insert anything into the safety interlock holes.
- Do not place any object between the oven door and front face or allow food or cleaner residues to accumulate on sealing surfaces. Ensure that the door and door sealing surfaces are kept clean by wiping after use first with a damp cloth and then with a soft dry cloth.
- Do not operate the oven if it is damaged until it has been repaired by a qualified microwave service technician trained by the manufacturer. It is particularly important that the oven door closes properly and that there is no damage to the:
 - Door, door seals and sealing surfaces
 - Door hinges (broken or loose)
 - Power cable
- The oven should not be adjusted or repaired by anyone other than a properly qualified microwave service technician trained by the manufacturer.

Safety Precautions

Important Safety Instructions.

Read Carefully and keep for future reference.

Before cooking food or liquids in your microwave oven, please check that the following safety precautions are taken.

- DO NOT** use any metallic cookware in the microwave oven:
 - Metallic containers
 - Dinnerware with gold or silver trimmings
 - Skewers, forks, etc.

Reason: Electric arcing or sparking may occur and may damage the oven.
- DO NOT** heat:
 - Airtight or vacuum-sealed bottles, jars, containers
 - Ex) Baby food jars
 - Airtight food.
 - Ex) Eggs, nuts in shells, tomatoes

Reason: The increase in pressure may cause them to explode.
Tip: Remove lids and pierce skins, bags, etc.
- DO NOT** operate the microwave oven when it is empty.

Reason: The oven walls may be damaged.
Tip: Leave a glass of water inside the oven at all times.
The water will absorb the microwaves if you accidentally set the oven going when it is empty.
- DO NOT** cover the rear ventilation slots with cloths or paper.

Reason: The cloths or paper may catch fire as hot air is evacuated from the oven.
- ALWAYS** use oven gloves when removing a dish from the oven.

Reason: Some dishes absorb microwaves and heat is always transferred from the food to the dish. The dishes are therefore hot.
- DO NOT** touch heating elements or interior oven walls.

Reason: These walls may be hot enough to burn even after cooking has finished, even though they do not appear to be so. Do not allow inflammable materials to come into contact with any interior area of the oven. Let the oven cool down first.
- To reduce the risk of fire in the oven cavity:
 - Do not store flammable materials in the oven
 - Remove wire twist ties from paper or plastic bags
 - Do not use your microwave oven to dry newspapers
 - If smoke is observed, keep the oven door closed and switch off or disconnect the oven from the power supply
- Take particular care when heating liquids and baby foods.
 - **ALWAYS** allow a standing time of at least 20 seconds after the oven has been switched off so that the temperature can equalize.
 - Stir during heating, if necessary, and **ALWAYS** stir after heating.
 - Take care when handling the container after heating. You may burn yourself if the container is too hot.

Safety Precautions

- A risk of delayed eruptive boiling exists.
- To prevent delayed boiling and possible scalding, you should put a plastic spoon or glass stick into the beverages and stir before, during and after heating.

Reason: During the heating of liquids the boiling point can be delayed; this means that eruptive boiling can start after the container is removed from the oven. You may scald yourself.

- In the event of scalding, follow these FIRST AID instructions:
 - * Immerse the scalded area in cold water for at least 10 minutes.
 - * Cover with a clean, dry dressing.
 - * Do not apply any creams, oils or lotions.
 - **NEVER** fill the container to the top and choose a container that is wider at the top than at the bottom to prevent the liquid from boiling over. Bottles with narrow necks may also explode if overheated.
 - **ALWAYS** check the temperature of baby food or milk before giving it to the baby.
 - **NEVER** heat a baby's bottle with the teat on, as the bottle may explode if overheated.
9. Be careful not to damage the power cable.
- Do not immerse the power cable or plug in water and keep the power cable away from heated surfaces.
 - Do not operate this appliance if it has a damaged power cable or plug.
10. Stand at arm's length from the oven when opening the door.
- Reason:** The hot air or steam released may cause scalding.
11. Keep the inside of the oven clean.
- Reason:** Food particles or spattered oils stuck to oven walls or floor can cause paint damage and reduce the efficiency of the oven.
12. You may notice a "Clicking" sound during operation (especially when the oven is defrosting).
- Reason:** This sound is normal when the electrical power output is changing.
13. When the microwave oven is operating without any load, the power will be cut off automatically for safety. You can operate normally after letting it stand for over 30 minutes.

IMPORTANT SAFETY INSTRUCTIONS

During cooking, you should look into the oven from time to time when food is being heated or cooked in disposable containers of plastic, paper or other combustible materials.

IMPORTANT

Young children or infirm persons should **NEVER** be allowed to use or play with the microwave oven. Nor should they be left unattended near the microwave oven when it is in use. Items of interest to children should not be stored or hidden just above the oven.

Installing Your Microwave oven

Place the oven on a flat, level surface that strong that is enough to safely bear the weight of the oven.

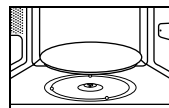
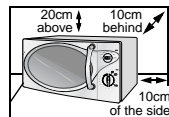

1. When you install your oven, make sure there is adequate ventilation for your oven by leaving at least 10 cm (4 inches) of space behind and, on the sides of the oven and 20 cm (8 inches) of space above.
2. Remove all packing materials inside the oven. Install the roller ring and turntable. Check that the turntable rotates freely.
3. This microwave oven has to be positioned so that plug is accessible.



Never block the air vents as the oven may overheat and automatically switch itself off. It will remain inoperable until it has cooled sufficiently.



For your personal safety, plug the cable into a 3-pin, 240 Volt, 50Hz, AC earthed socket. If the power cable of this appliance is damaged, it must be replaced by a special cable. Contact your local dealer to have it replaced.



Do not install the microwave oven in hot or damp surroundings like next to a traditional oven or radiator. The power supply specifications of the oven must be respected and any extension cable used must be of the same standard as the power cable supplied with the oven. Wipe the interior and the door seal with a damp cloth before using your microwave oven for the first time.

What to Do if You are in Doubt or Have a Problem

If you have any of the problems listed below try the solutions given.

- ◆ This is normal.
 - Condensation inside the oven
 - Air flow around the door and outer casing
 - Light reflection around the door and outer casing
 - Steam escaping from around the door or vents
- ◆ The oven does not start when you turn the **TIMER** knob.
 - Is the door completely closed?
- ◆ The food is not cooked at all
 - Have you set the timer correctly?
 - Is the door closed?
 - Have you overloaded the electric circuit and caused a fuse to blow or a breaker to be triggered?
- ◆ The food is either overcooked or undercooked
 - Was the appropriate cooking length set for the type of food?
 - Was an appropriate power level chosen?
- ◆ Sparking and cracking occur inside the oven (arcing)
 - Have you used a dish with metal trimmings?
 - Have you left a fork or other metal utensil inside the oven?
 - Is aluminium foil too close to the inside walls?
- ◆ The oven causes interference with radios or televisions
 - Slight interference may be observed on televisions or radios when the oven is operating. This is normal. To solve this problem, install the oven away from televisions, radios and aerials.
- ☒ If the above guidelines do not enable you to solve the problem, contact your local dealer or SAMSUNG after-sales service.

Cooking / Reheating

The following procedure explains how to cook or reheat food. **ALWAYS** check your cooking settings before leaving the oven unattended.

First, place the food in the centre of the turntable. Then, close the door.

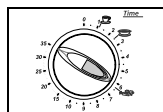
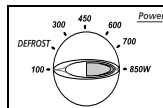

1. Select the power level to maximum by turning **COOKING POWER CONTROL** knob. **(MAXIMUM POWER: 850 W)**

2. Select the time by turning **TIMER** knob.
Result: The oven light comes on and the turntable starts rotating.



Never switch the microwave oven on when it is empty.



You can change the power level during cooking by turning the **COOKING POWER CONTROL** knob.



The oven must be plugged into an appropriate wall socket. The turntable must be in position in the oven. If a power level other than the maximum is used, the water takes longer to boil.

Power Levels

You can choose any of the power levels listed below.

| Power Level | Output |
|--------------------|--------|
| HIGH | 850 W |
| REHEAT | 700 W |
| MEDIUM HIGH | 600 W |
| MEDIUM | 450 W |
| MEDIUM LOW | 300 W |
| MANUAL DEFROST (☞) | 180 W |
| LOW / KEEP WARM | 100 W |



If you select higher power level, the cooking time must be decreased.



If you select lower power level, the cooking time must be increased.

Stopping the Cooking

You can stop cooking at any time to check the food.

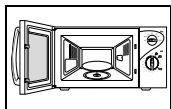

1. To stop temporarily;
Open the door.
Result : Cooking stops. To resume cooking, close the door.
2. To stop Completely;
Turn the **TIMER** knob to "0".

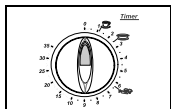

Adjusting the Cooking Time

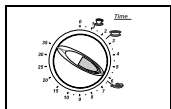

Adjust the remaining cooking time by rotating the **TIMER** knob.

Manual Defrosting of Food

The Manual Defrost feature enables you to defrost meat, poultry fish or fruit. First, place the frozen food in the centre of the turntable and close the door.

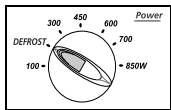

1. Turn the **COOKING POWER CONTROL** knob to the **Manual Defrost** (☞) symbol.

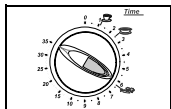

2. Turn the **TIMER** knob to select the appropriate time.
Result : Defrosting begins.



Use only recipients that are microwave-safe.

Using the Instant Reheat Feature

First, place the food in the center of the turntable and close the door.

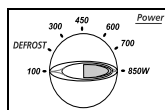

1. Turn the **COOKING POWER CONTROL** knob to Max. Power.

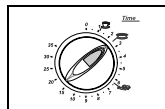

2. Turn the **TIMER** knob to select Instant Reheat. (drinks or soup/sauce, fresh vegetables).



Use only recipients that are microwave-safe.

Instant Reheat Settings

Here are a few tips and recommendations to be followed when cooking or reheating food with the Instant Reheat and Cooking Feature.

| Symbols | Food | Serving Size | Cooking Time | Standing Time |
|---------|----------------------|--------------|--------------|---------------|
| | Drinks | 150 ml | 1 min 5 sec | 1 - 2 min. |
| | Soup/Sauce (chilled) | 200-250 ml | 2 min 30 sec | 2 - 3 min. |
| | Fresh vegetables | 300-350 g | 6 min 20 sec | 3 min. |

Cookware Guide

To cook food in the microwave oven, the microwaves must be able to penetrate the food, without being reflected or absorbed by the dish used.

Care must therefore be taken when choosing the cookware. If the cookware is marked microwave-safe, you do not need to worry.

The following table lists various types of cookware and indicates whether and how they should be used in a microwave oven.

| Cookware | Microwave-Safe | Comments |
|---------------------------------------|----------------|---|
| Aluminium foil | ✓ X | Can be used in small quantities to protect areas against overcooking. Arcing can occur if the foil is too close to the oven wall or if too much foil is used. |
| Browning plate | ✓ | Do not preheat for more than eight minutes. |
| China and earthenware | ✓ | Porcelain, pottery, glazed earthenware and bone china are usually suitable, unless decorated with a metal trim. |
| Disposable polyester cardboard dishes | ✓ | Some frozen foods are packaged in these dishes. |
| Fast-food packaging | | |
| • Polystyrene cups containers | ✓ | Can be used to warm food. Overheating may cause the polystyrene to melt. |
| • Paper bags or newspaper | X | May catch fire. |
| • Recycled paper or metal trims | X | May cause arcing. |
| Glassware | | |
| • Oven-to-table ware | ✓ | Can be used, unless decorated with a metal trim. |
| • Fine glassware | ✓ | Can be used to warm foods or liquids. Delicate glass may break or crack if heated suddenly. |
| • Glass jars | ✓ | Must remove the lid. Suitable for warming only. |

| Metal | | |
|---|-----|--|
| • Dishes | X | May cause arcing or fire. |
| • Freezer bag twist ties | X | |
| Paper | | |
| • Plates, cups, napkins and Kitchen paper | ✓ | For short cooking times and warming. Also to absorb excess moisture. |
| • Recycled paper | X | May cause arcing. |
| Plastic | | |
| • Containers | ✓ | Particularly if heat-resistant thermoplastic. Some other plastics may warp or discolour at high temperatures. Do not use Melamine plastic. |
| • Cling film | ✓ | Can be used to retain moisture. Should not touch the food. Take care when removing the film as hot steam will escape. |
| • Freezer bags | ✓ X | Only if boilable or oven-proof. Should not be airtight. Prick with a fork, if necessary. |
| Wax or grease-proof paper | ✓ | Can be used to retain moisture and prevent spattering. |

✓ :Recommended

✓X :Use Caution

X :Unsafe

Cleaning Your Microwave Oven

GB The following parts of your microwave oven should be cleaned regularly to prevent grease and food particles from building up:

- **Inside and outside surfaces**
- **Door and door seals**
- **Turntable and Roller rings**

✎ **ALWAYS** ensure that the door seals are clean and that the door closes properly.

1. Clean the outside surfaces with a soft cloth and warm, soapy water. Rinse and dry.
2. Remove any splashes or stains on the inside surfaces or on the roller ring with a soapy cloth. Rinse and dry.
3. To loosen hardened food particles and remove smells, place a cup of diluted lemon juice on the turntable and heat for ten minutes at maximum power.
4. Wash the dishwasher-safe plate whenever necessary.

✎ **DO NOT** spill water in the vents. NEVER use any abrasive products or chemical solvents. Take particular care when cleaning the door seals to ensure that no particles:

- Accumulate
- Prevent the door from closing correctly

Technical Specifications

SAMSUNG strives to improve its products at all times. Both the design specifications and these user instructions are thus subject to change without notice.

| | |
|---|--|
| Model | M1817N |
| Power source | 240V ~ 50 Hz |
| Power consumption Microwave | 1250 W |
| Output power | 100 W / 850 W (IEC-705) |
| Operating frequency | 2450 MHz |
| Magnetron | OM75P(31) |
| Cooling method | Cooling fan motor |
| Dimensions (W x H x D) Outside Oven cavity | 489 x 275 x 397 mm 330 x 211 x 329 mm |
| Volume | 23 liter |
| Weight Net | 13.5 kg approx |

